

# Tehnicki list

Reduktor, PG-navoj

Broj artikla: 2030705

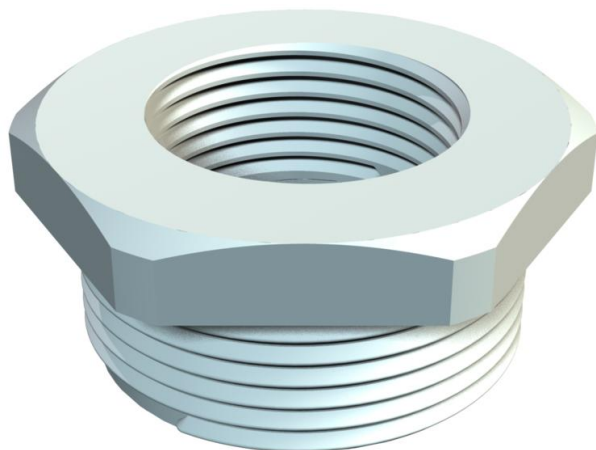

Adapter, PG-unutrašnji i spoljašnji navoj prema 40430.



PA poliamid

## Matični podaci

Broj artikla	2030705
Tip	107 R PG11- 7 PA
Oznaka 1	Reducir
Proizvođač	OBO
Dimenzija	PG11-PG7
Boja	svetlo siva; RAL 7035
Materijal	Poliamid
Smallest sales unit	50
Jedinica količine	Komad
Weight	0,4 kg
Jedinica težine	kg/100 pari

# Tehnicki list

Reduktor, PG-navoj

Broj artikla: 2030705



## Dimenzije

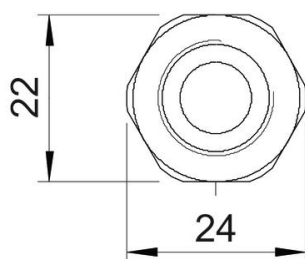
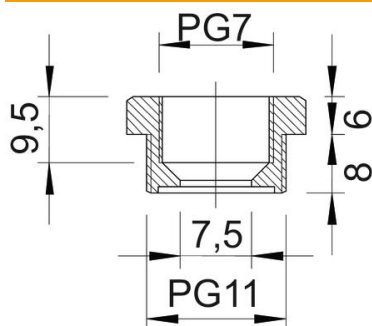

Dimension D	7,5 mm
Dimension E	24 mm
Dimension L1	8 mm
Dimension L2	6 mm
Dimension L3	9,5 mm

## Tehnički podaci

zaštićeno od eksplozije	ne
Vrsta navoja spoljni navoj	PG
Vrsta navoja unutrašnji navoj	PG
Dužina navoja	8 mm
Dimenzije navoja PG spolja	11
Dimenzije navoja PG unutra	7
bez halogena	da
širina ključa	22
Niklovano	ne