

Technical data sheet

Separating retainer 45 A4

Item number: 6062028



Separating retainer for the separation of cables of different voltages or functions.



A4 Stainless steel

2B Bright, treated

Master data

Item number	6062028
Type	TSG 45 A4
Description 1	Barrier strip
Description 2	for cable support systems
Manufacturer	OBO
Dimension	45x2995
Material	Stainless steel
Surface	Bright, treated
Surface standard	
Smallest sales unit	3
Unit of quantity	Metre
Weight	49.85 kg
Weight unit	kg/100 m

Technical data sheet

Separating retainer 45 A4

Item number: 6062028



Dimensions

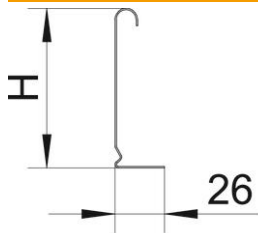

Length	3,000 mm
Length	10 ft
Height	45 mm
Height	1 in
Plate thickness	0.75 mm
Dimension H (Inch)	1 in
Dimension H	45 mm
Dimension L	10 ft
Dimension L	3,000 mm

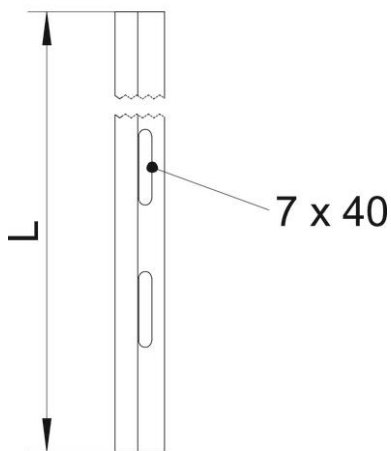

Technical data

Version for	L profile
Fastening type	Screw-on
Fastening perforation (ETIM)	no
Maintain electrical functions	no
Suitable for mesh cable tray	yes
Suitable for cable ladder	yes
Suitable for cable tray	yes
Rustproof steel, pickled	no